

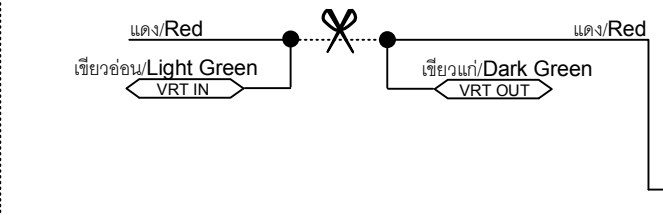

Wiring Diesel Monster MAX KD TOYOTA VIGO (Part I)

สายสีน้ำเงิน
Blue Wire

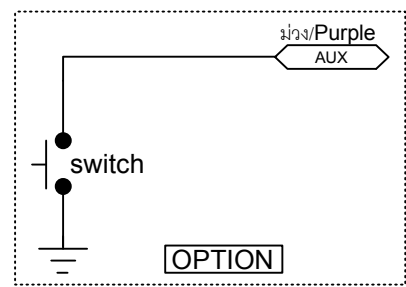
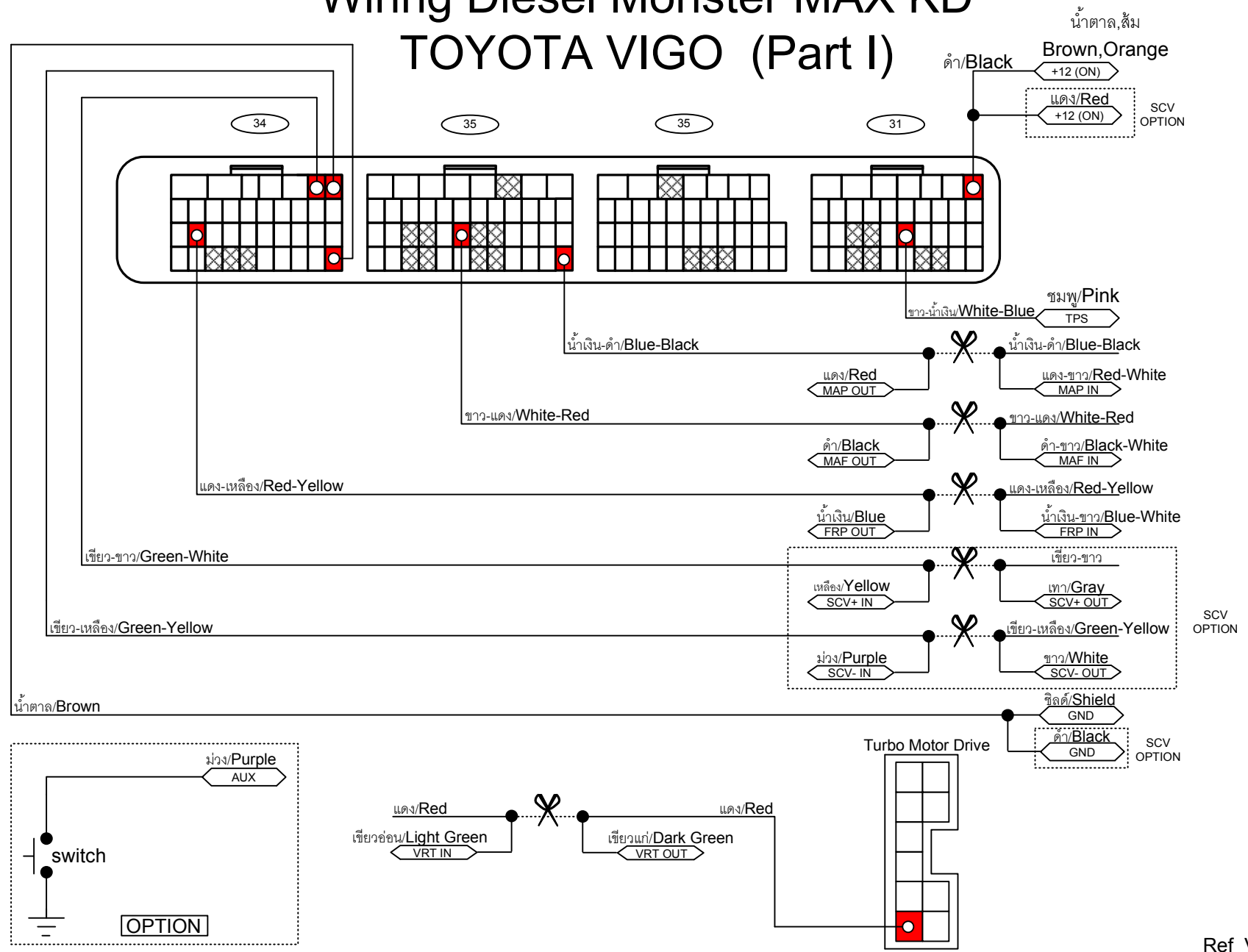
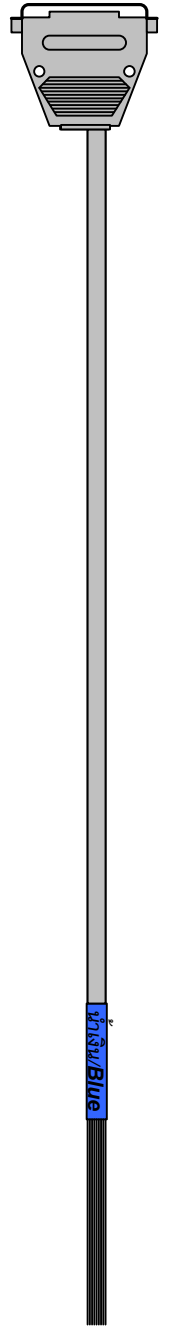

*** สายที่เหลือง(เหลือง-ขาว, เหลือง, ขาว, เทา)ให้หุ้มท่อหัดแล้วแยกแต่ละเส้นไว้ ***

สายสีเขียว
Green Wire

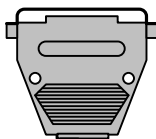

Wiring Diesel Monster MAX KD TOYOTA VIGO (Part II)

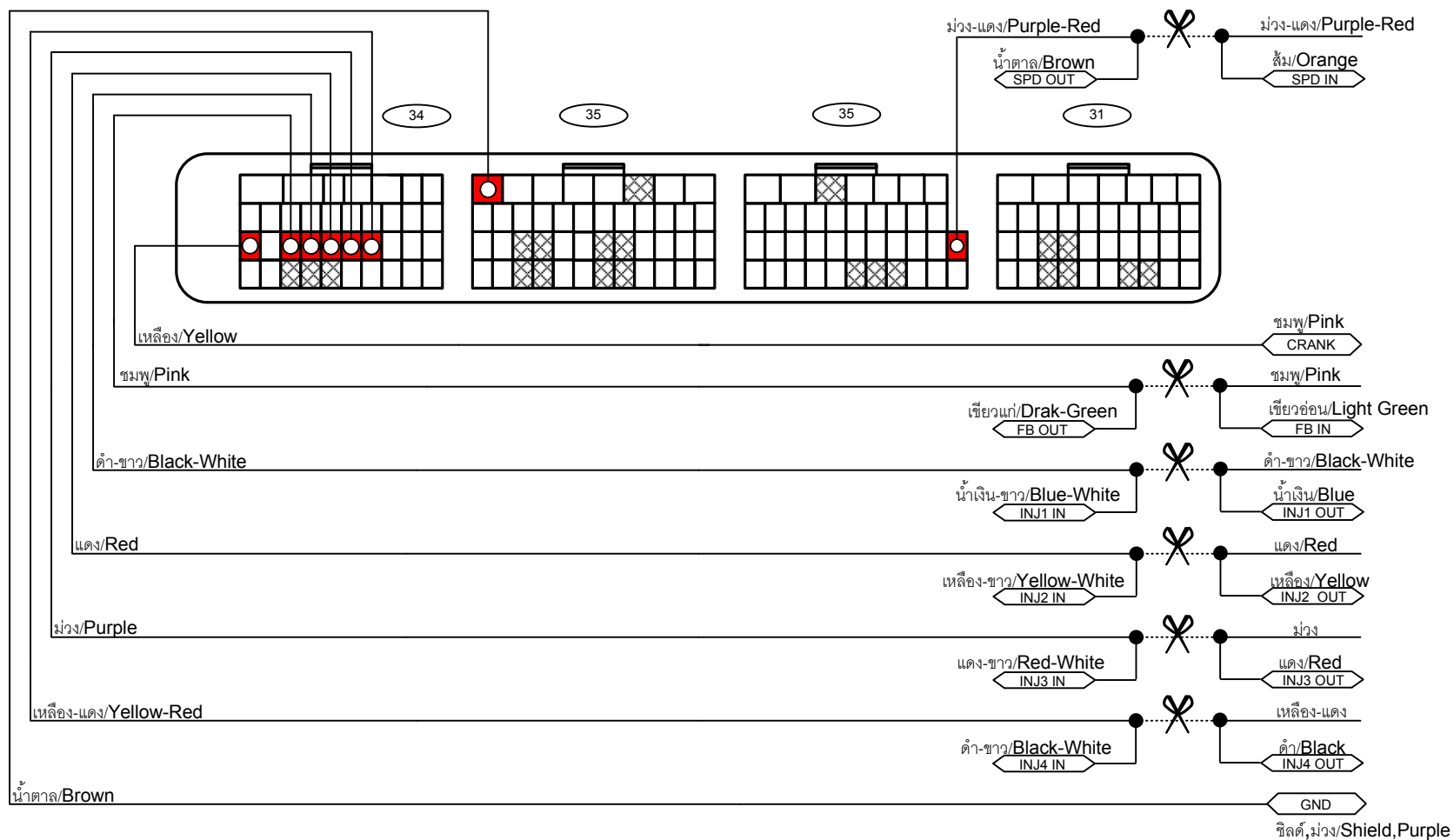

FEEDBACK SIGNAL	DELAY	EXTRA
	14	2



Wiring Diesel Monster MAX KD TOYOTA VIGO VNT (EDU 3 Plug) Part I

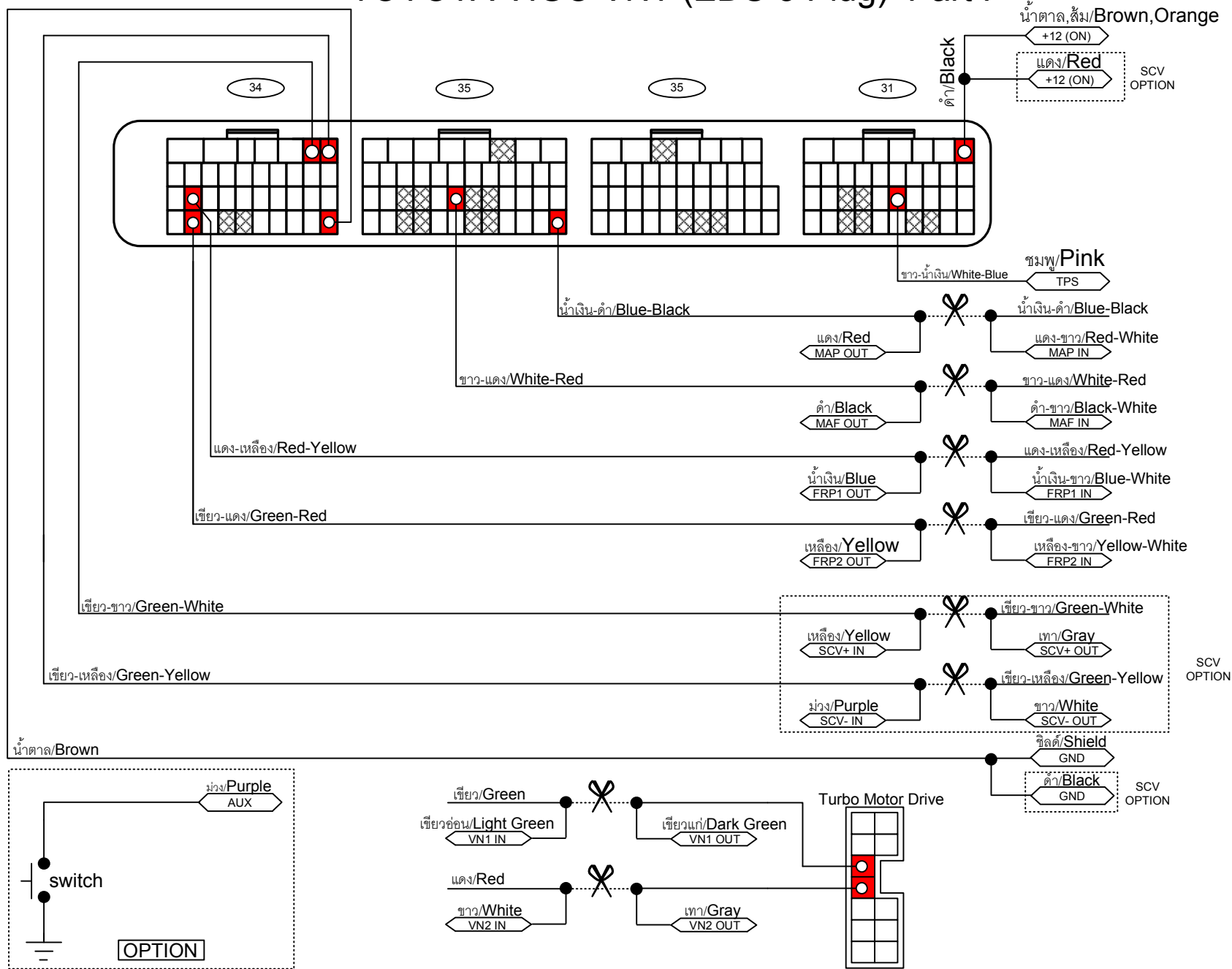
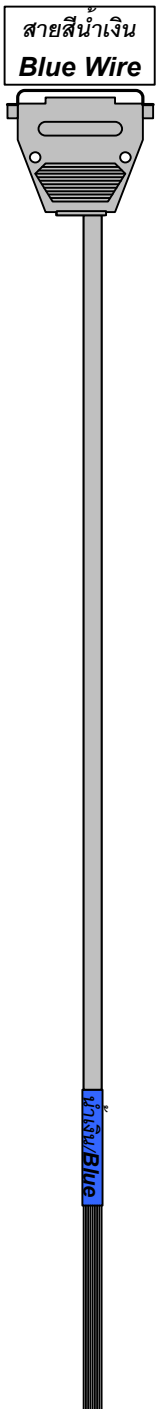

สายสีเขียว
Green Wire

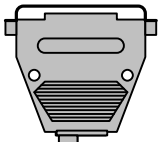

Wiring Diesel Monster MAX KD TOYOTA VIGO VNT (EDU 3 Plug) Part II

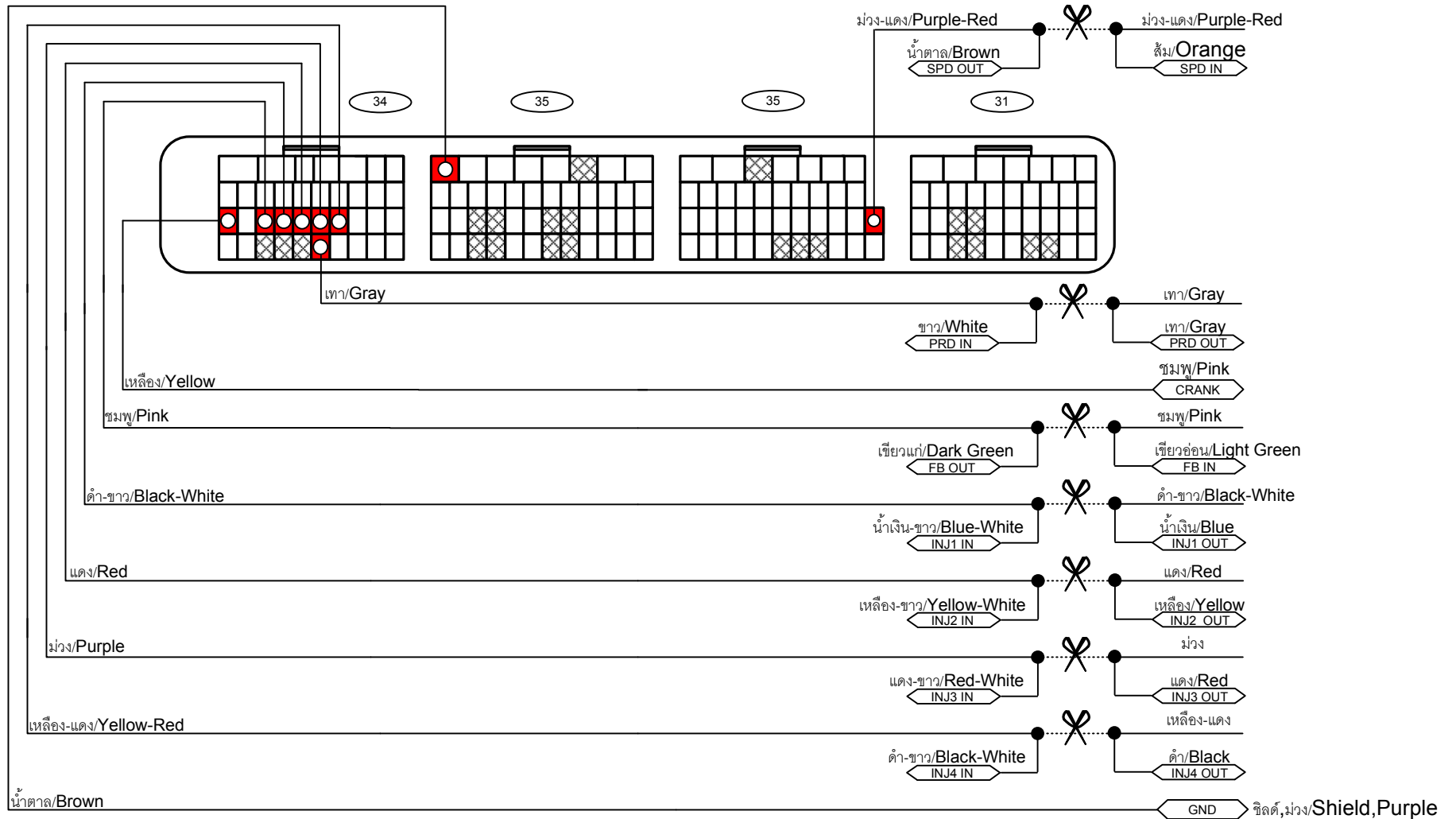

FEEDBACK SIGNAL DELAY EXTRA

 14 2



Wiring Diesel Monster MAX KD TOYOTA (ECU 6 Plug with EDU4 Plug) Part I

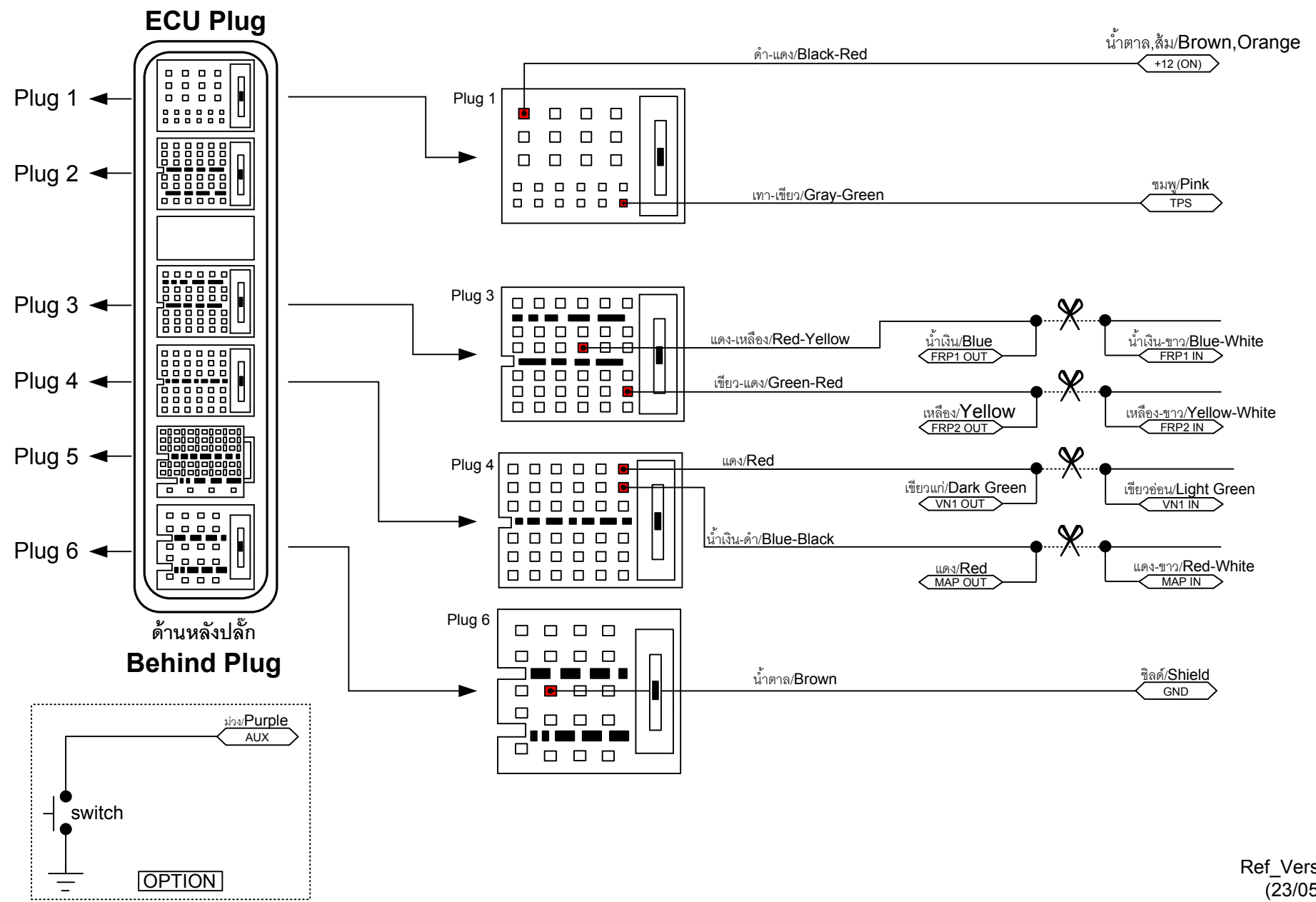
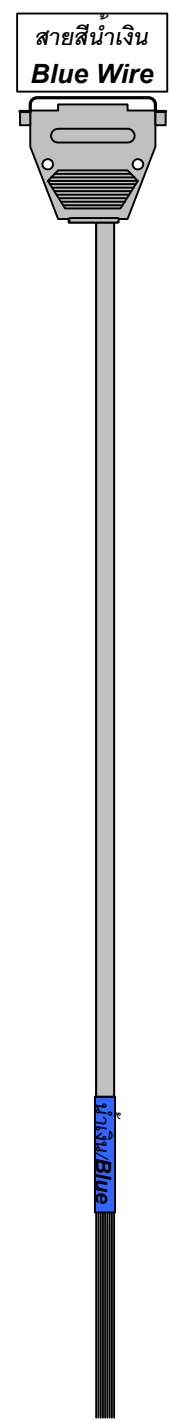



Wiring Diesel Monster MAX KD TOYOTA (ECU 6 Plug with EDU4 Plug) Part II

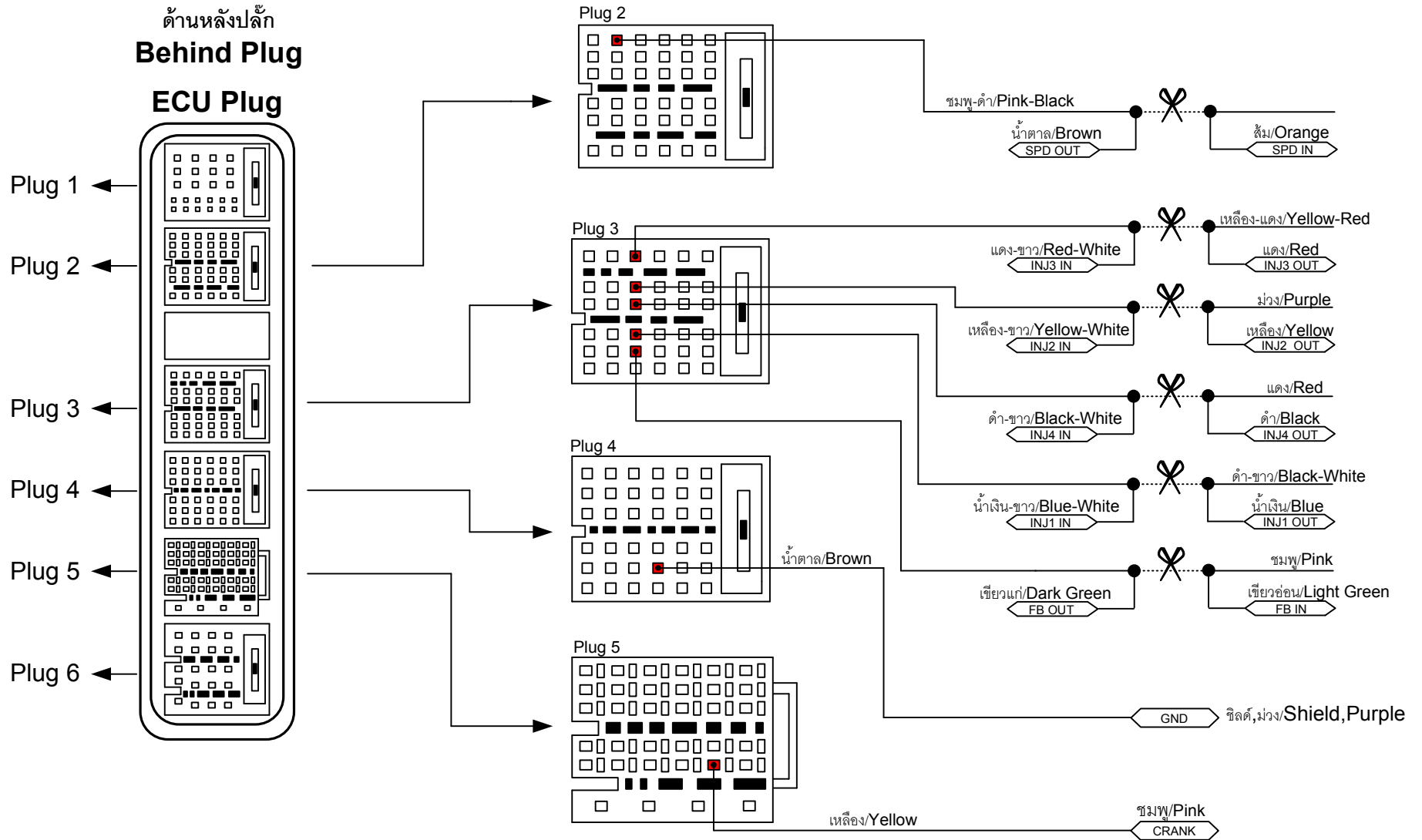
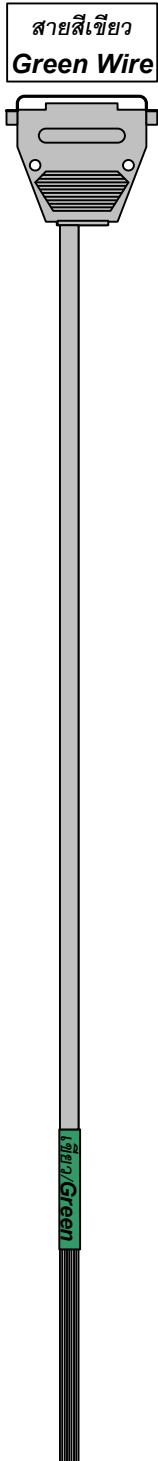

FEEDBACK SIGNAL DELAY EXTRA

2 14



Wiring Diesel Monster MAX KD TOYOTA COMMUTER 3.0 MT (ECU 2 Plug) Part I

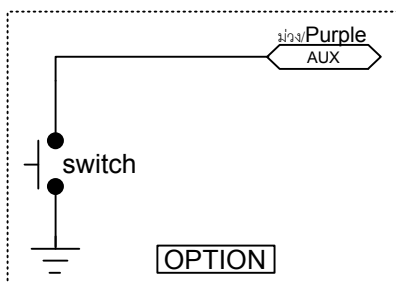
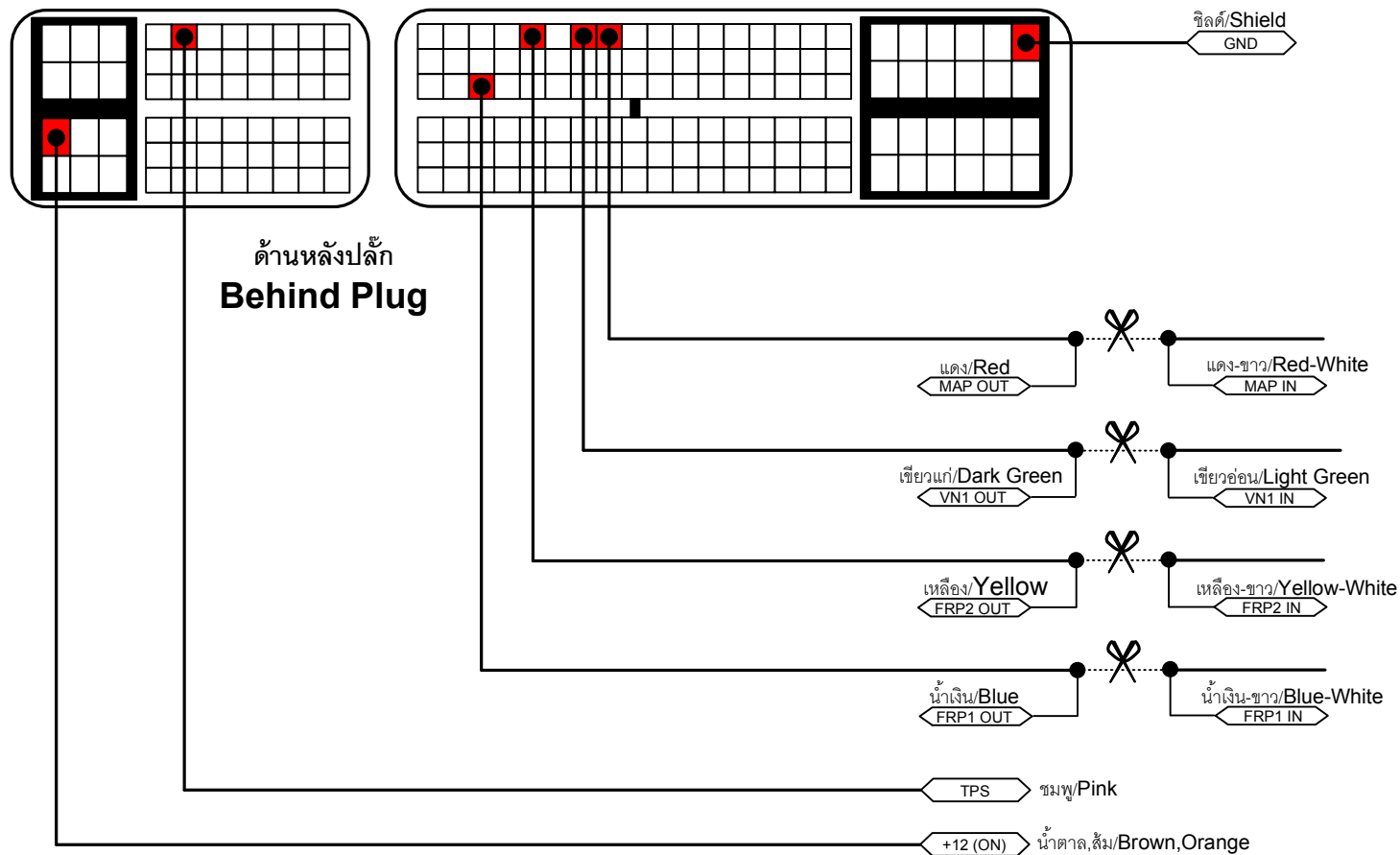
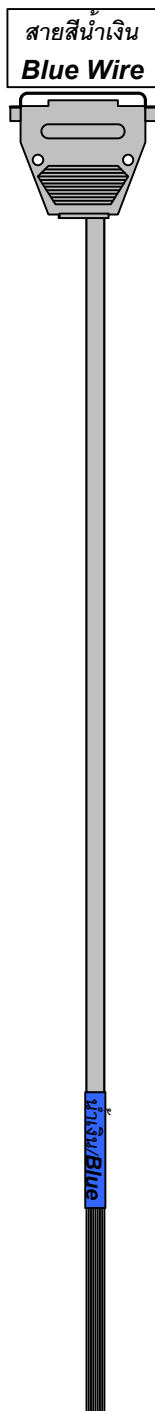

** ยังไม่มีฟังก์ชัน Unlock Speed **



Wiring Diesel Monster MAX KD TOYOTA COMMUTER 3.0 MT (ECU 2 Plug) Part II

สายสีเขียว
Green Wire

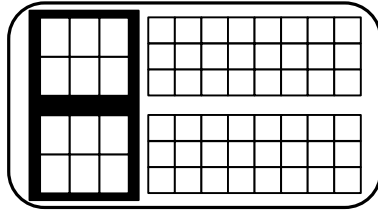
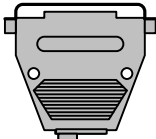

ด้านหลังปลั๊ก
Behind Plug

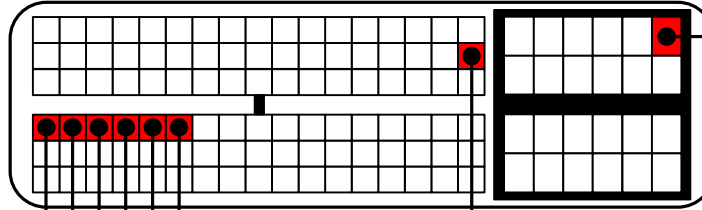

GND ชิลด์, ม่วง/ Shield, Purple

ชมพู/Pink
CRANK

ขาว/White
PRD IN

เทา/Gray
PRD OUT

เขียวแก่/Dark Green
FB OUT

เขียวอ่อน/Light Green
FB IN

น้ำเงิน-ขาว/Blue-White
INJ1 IN

น้ำเงิน/Blue
INJ1 OUT

เหลือง-ขาว/Yellow-White
INJ2 IN

เหลือง/Yellow
INJ2 OUT

แดง-ขาว/Red-White
INJ3 IN

แดง/Red
INJ3 OUT

ดำ-ขาว/Black-White
INJ4 IN

ดำ/Black
INJ4 OUT

** ยังไม่มีฟังก์ชัน Unlock Speed **

FEEDBACK SIGNAL	DELAY	EXTRA
	14	2

Wiring Diesel Monster MAX KD

TOYOTA HIACE M/T (ECU 6 Plug with EDU3 Plug) Part I

สายสีน้ำเงิน
Blue Wire

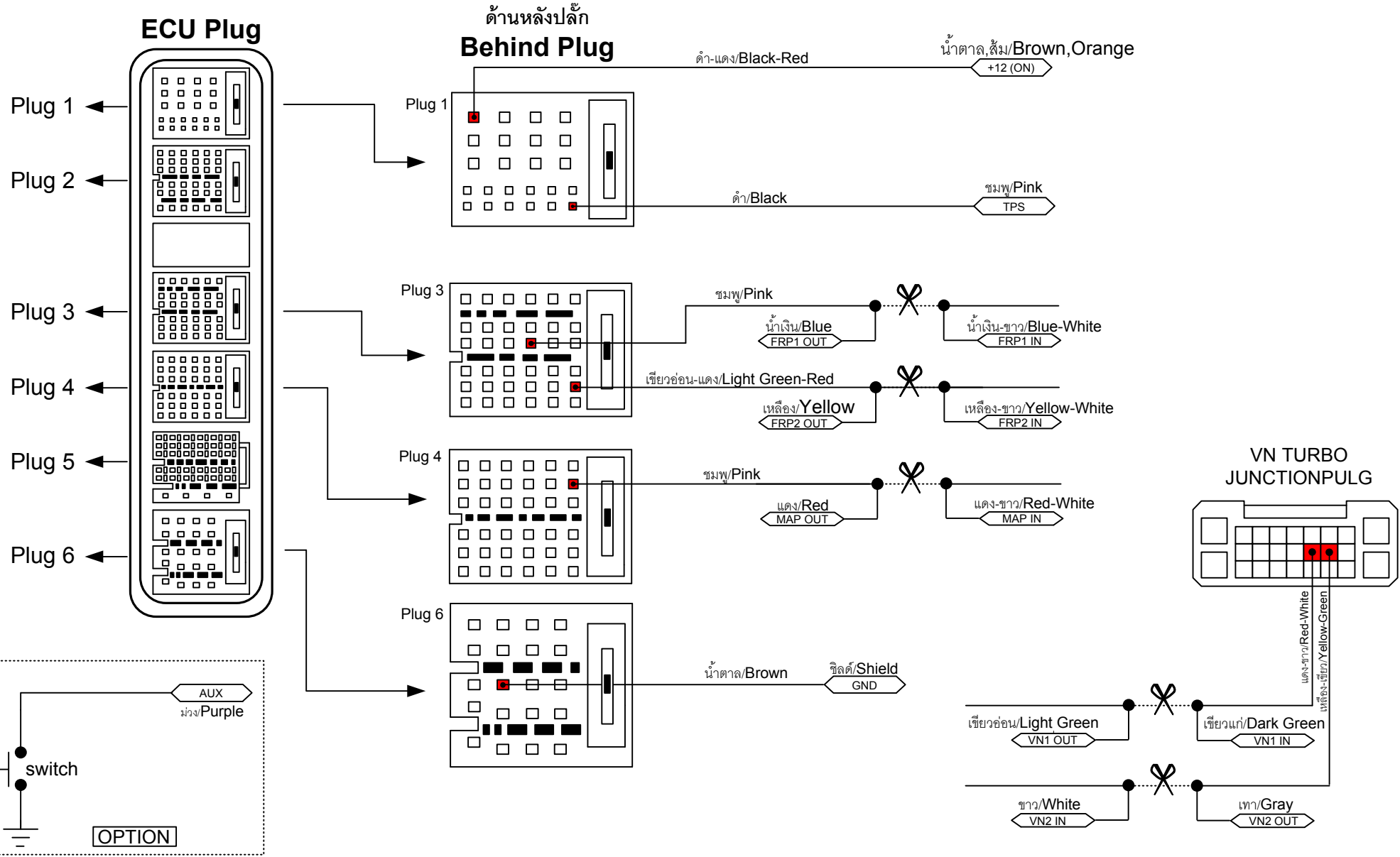
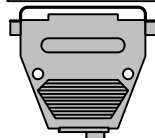



สายสีเขียว
Green Wire

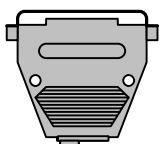

Wiring Diesel Monster MAX KD TOYOTA HIACE M/T (ECU 6 Plug with EDU3 Plug) Part II

